

Modeling with UML: Basic Notations II

**Introduction to Software Engineering Lecture 3
24 April 2007**

Prof. Bernd Bruegge, Ph.D.
*Applied Software Engineering
Technische Universitaet Muenchen*

Outline of this Class

- **Use case diagrams**
 - Describe the functional behavior of the system as seen by the user
- **Class diagrams**
 - Describe the static structure of the system: Objects, attributes, associations
- **Sequence diagrams**
 - Describe the dynamic behavior between objects of the system
- **Statechart diagrams**
 - Describe the dynamic behavior of an individual object
- **Activity diagrams**
 - Describe the dynamic behavior of a system, in particular the workflow.

Miscellaneous

- May 1st is a holiday (Tag der Arbeit)
 - No lecture on Tuesday, Mai 1st
 - No exercise sessions on April 30th and Mai 1^s
- Student certificates
 - If your certificate was issued before March 2007, your certificate expires on May 31, 2007.
 - New passwords can be obtained by
 - Frau auf der Landwehr
 - Normal Opening times: see
 - <http://wwwsbs.in.tum.de/personen/adland>
 - Additional Opening times:
 - Mo-Mi 11:00-12:00
 - Do: 13:00-14:00.

What is UML? Unified Modeling Language

- Convergence of different notations used in object-oriented methods, mainly
 - OMT (James Rumbaugh and colleagues), OOSE (Ivar Jacobson), Booch (Grady Booch)
- They also developed the Rational Unified Process, which became the Unified Process in 1999



25 year at GE Research, where he developed OMT, joined (IBM) Rational in 1994, CASE tool OMTTool



At Ericsson until 1994, developed use cases and the CASE tool Objectory, at IBM Rational since 1995, <http://www.ivarjacobson.com>

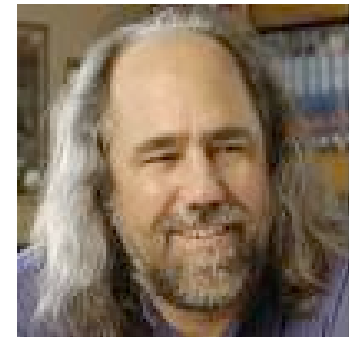

Developed the Booch method (“clouds”), ACM Fellow 1995, and IBM Fellow 2003 <http://www.booch.com/>

UML

- Nonproprietary standard for modeling systems
- Current Version 2.0
 - Information at the OMG portal <http://www.uml.org/>
- Commercial tools:
 - Rational (IBM), Together (Borland), Visual Architect (Visual Paradigm), Enterprise Architect (Sparx Systems)
- Open Source tools <http://www.sourceforge.net/>
 - ArgoUML, StarUML, Umbrello (for KDE), PoseidonUML
- Research Tool used at our chair: Sysiphus
 - Based on a unified project model for modeling, collaboration and project organization
 - <http://sysiphus.in.tum.de/>.



UML: First Pass

- You can solve 80% of the modeling problems by using 20 % UML
- We teach you those 20%
- 80-20 rule: Pareto principle



Vilfredo Pareto, 1848-1923
Introduced the concept of Pareto
Efficiency,
Founder of the field of microeconomics.

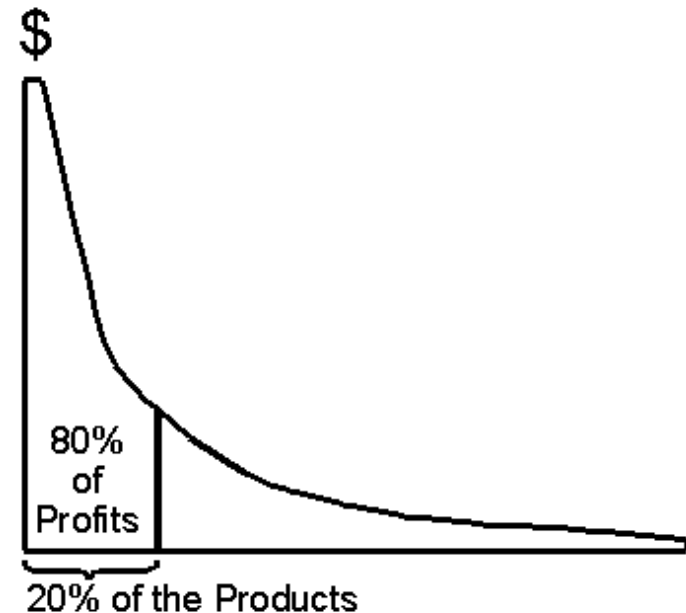

UML First Pass

- **Use case diagrams**
 - Describe the functional behavior of the system as seen by the user
- **Class diagrams**
 - Describe the static structure of the system: Objects, attributes, associations
- **Sequence diagrams**
 - Describe the dynamic behavior between objects of the system
- **Statechart diagrams**
 - Describe the dynamic behavior of an individual object
- **Activity diagrams**
 - Describe the dynamic behavior of a system, in particular the workflow.

UML Core Conventions

- All UML diagrams denote graphs of nodes and edges
 - Nodes are **entities** and drawn as rectangles or ovals
 - Rectangles denote **classes** or objects (instances)
 - Ovals denote **functions**
- Names of classes are not underlined
 - SimpleWatch
 - Firefighter
- Names of instances are underlined
 - myWatch:SimpleWatch
 - Joe:Firefighter
- An edge between two nodes denotes a **relationship** between the corresponding entities
 - Relationships between classes are called **associations**.

UML first pass: Use case diagrams

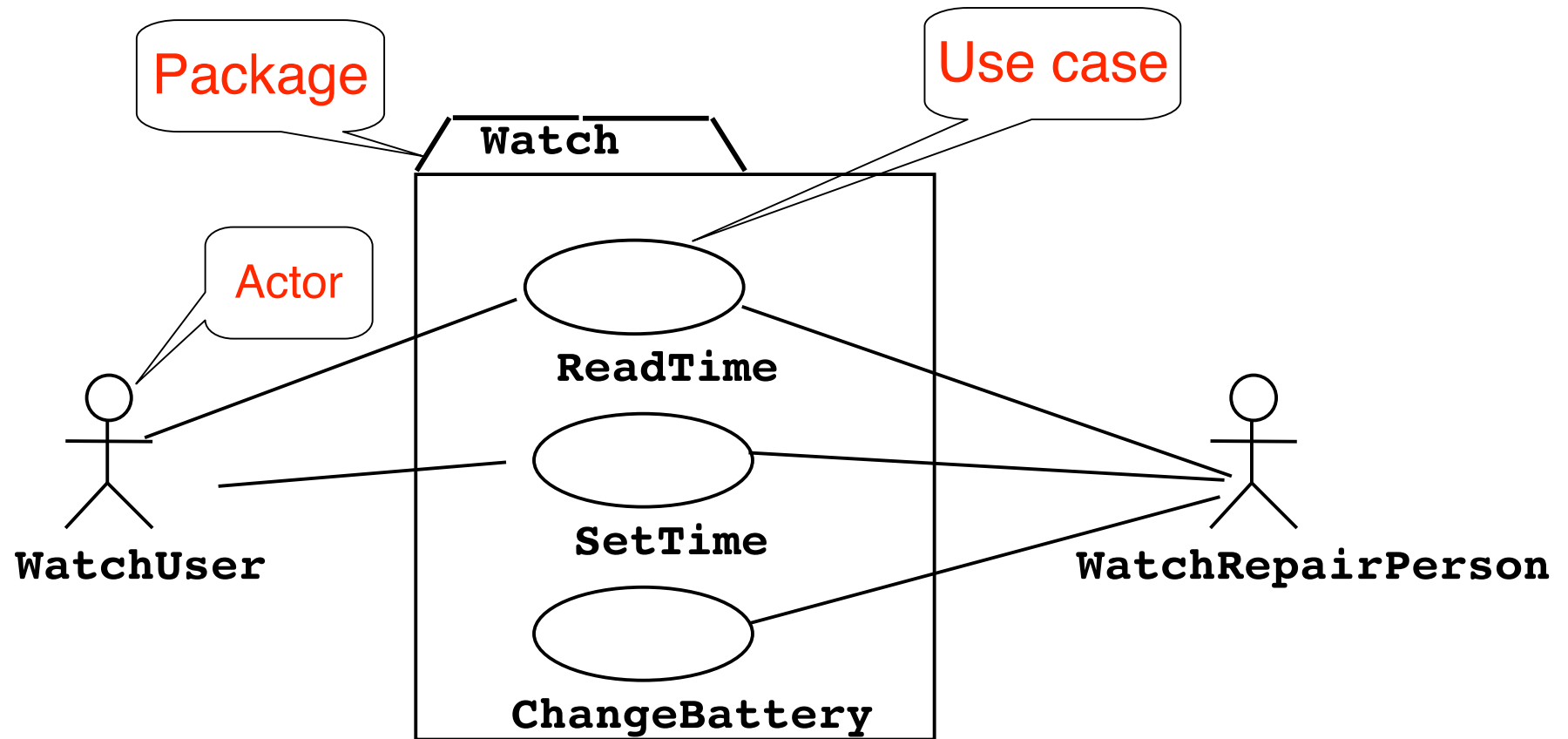

Use case diagrams represent the **functionality** of the system from **user's** point of view

UML first pass: Class diagrams

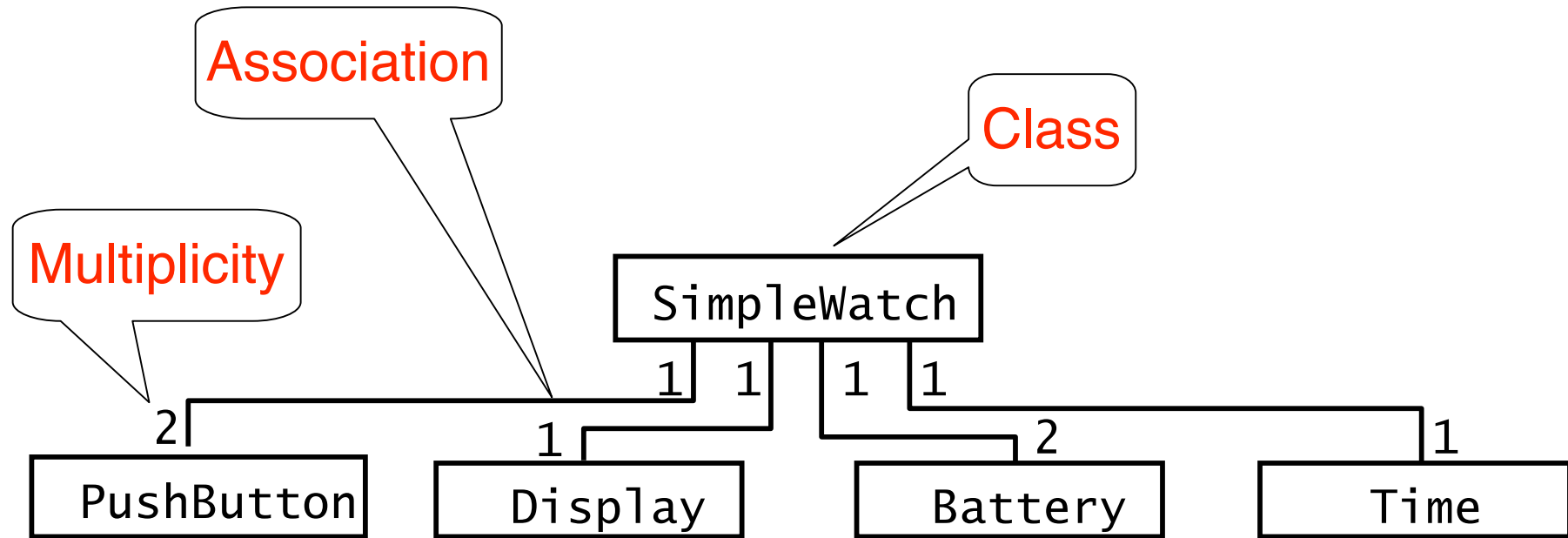

Class diagrams represent the **structure** of the system

UML first pass: Class diagrams

Class diagrams represent the **structure** of the system

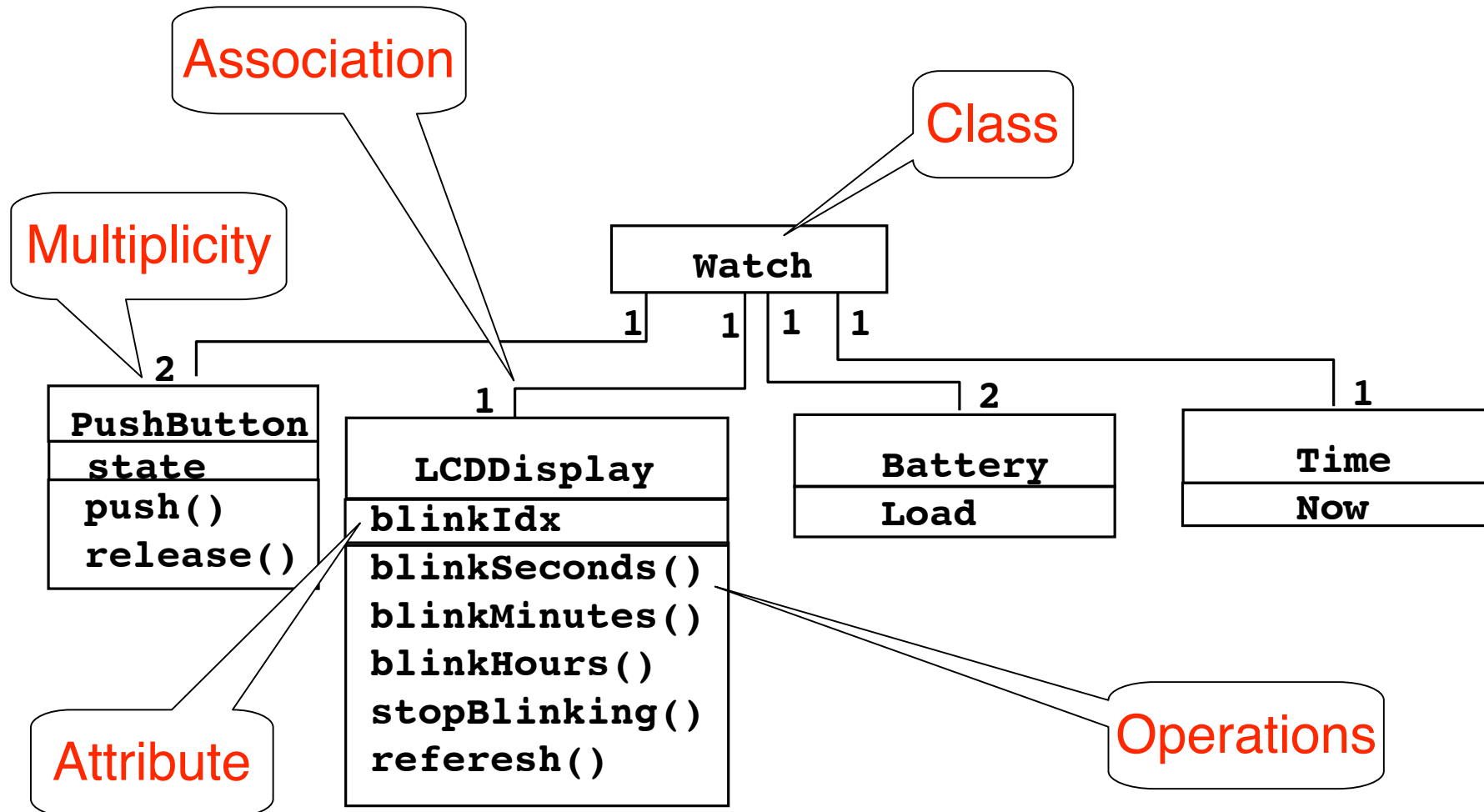

UML first pass: Sequence diagram

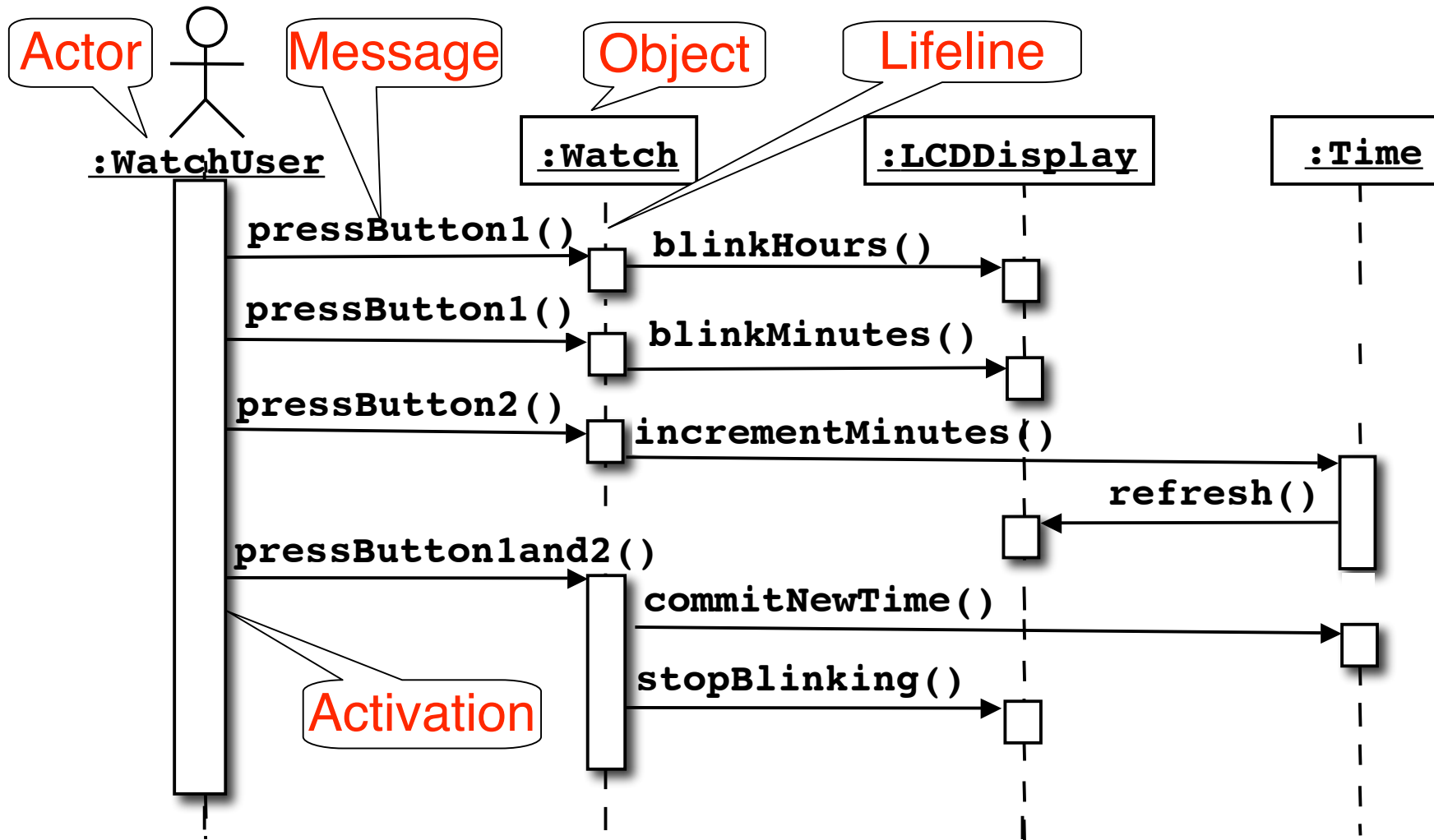

Sequence diagrams represent the **behavior** of a system as messages (“interactions”) **between different objects**

UML first pass: Statechart diagram

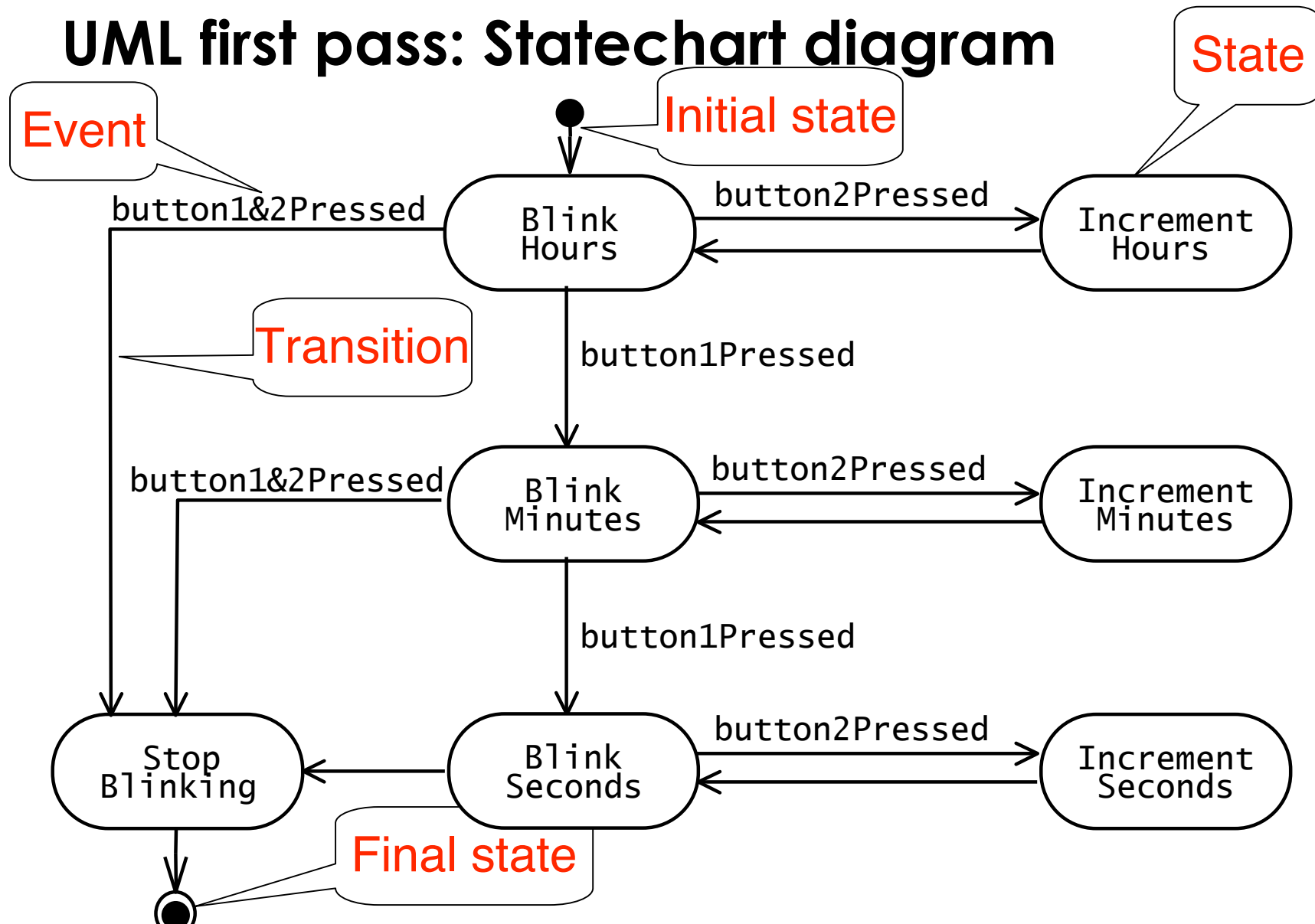

Represents *behavior of a single object* with interesting dynamic behavior.

Other UML Notations

UML provides many other notations

- Activity diagrams for modeling work flows
- Deployment diagrams for modeling configurations (for testing and release management)

What should be done first? Coding or Modeling?

- It all depends....
- **Forward Engineering**
 - Creating the code from a model
 - Start with modeling
 - Greenfield projects
- **Reverse Engineering**
 - Creation of a model from existing code
 - Interface or reengineering projects
- **Roundtrip Engineering**
 - Move constantly between forward and reverse engineering
 - Reengineering projects
 - Useful when requirements, technology and schedule are changing frequently.

UML Basic Notation: First Summary

- UML provides a wide variety of notations for modeling many aspects of software systems
- We concentrate on a few notations:
 - Functional model: Use case diagram
 - Object model: Class diagram
 - Dynamic model: Sequence diagrams, statechart
- Now we go into a little bit more detail...

UML Use Case Diagrams

Used during requirements elicitation and analysis to represent external behavior (“visible from the outside of the system”)

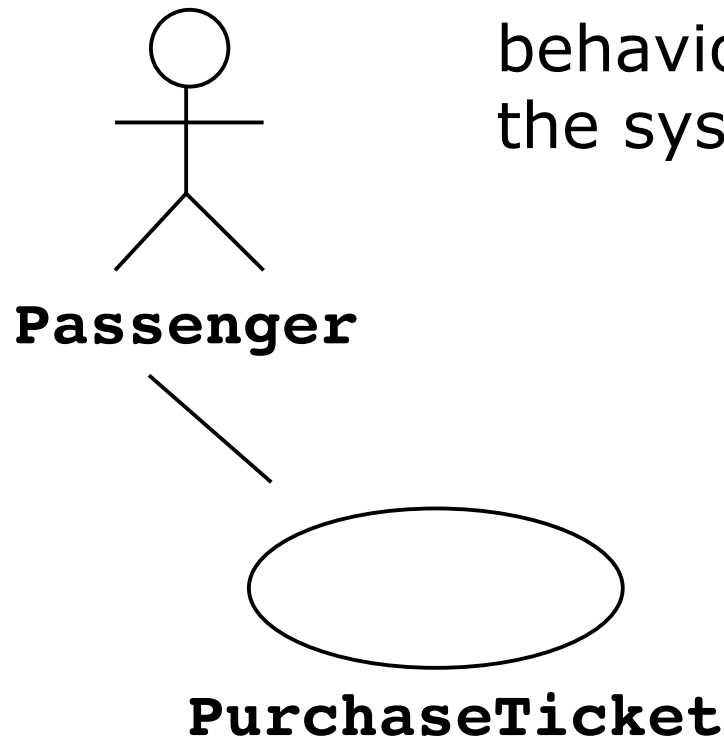

An **Actor** represents a role, that is, a type of user of the system

A **use case** represents a class of functionality provided by the system

Use case model:

The set of all use cases that completely describe the functionality of the system.

Actors

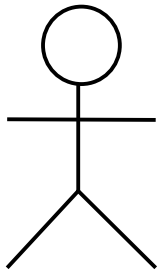

Passenger

- An actor is a model for an external entity which interacts (communicates) with the system:

- User
- External system (Another system)
- Physical environment (e.g. Weather)

- An actor has a unique name and an optional description

- Examples:

- **Passenger**: A person in the train
- **GPS satellite**: An external system that provides the system with GPS coordinates.

Name

**Optional
Description**

Use Case

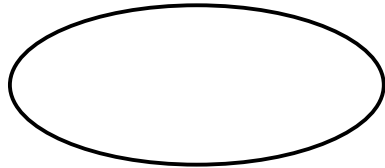

PurchaseTicket

- A use case represents a class of functionality provided by the system
- Use cases can be described textually, with a focus on the event flow between actor and system
- The textual use case description consists of 6 parts:
 1. Unique name
 2. Participating actors
 3. Entry conditions
 4. Exit conditions
 5. Flow of events
 6. Special requirements.

Textual Use Case Description Example 4 24 2007

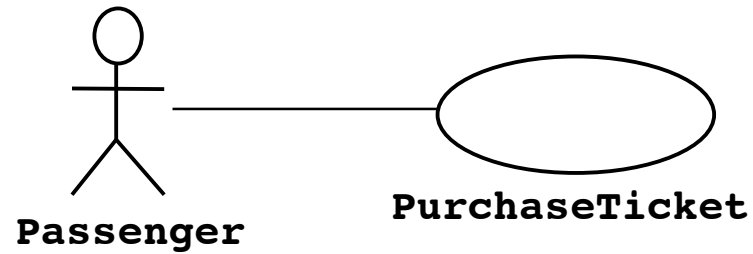

1. Name: Purchase ticket

2. Participating actor:
Passenger

3. Entry condition:

- Passenger stands in front of ticket distributor
- Passenger has sufficient money to purchase ticket

4. Exit condition:

- Passenger has ticket

5. Flow of events:

1. Passenger selects the number of zones to be traveled
2. Ticket Distributor displays the amount due
3. Passenger inserts money, at least the amount due
4. Ticket Distributor returns change
5. Ticket Distributor issues ticket

6. Special requirements:
None.

Uses Cases can be related

- **Extends Relationship**
 - To represent seldom invoked use cases or exceptional functionality
- **Includes Relationship**
 - To represent functional behavior common to more than one use case.

The <<extends>> Relationship

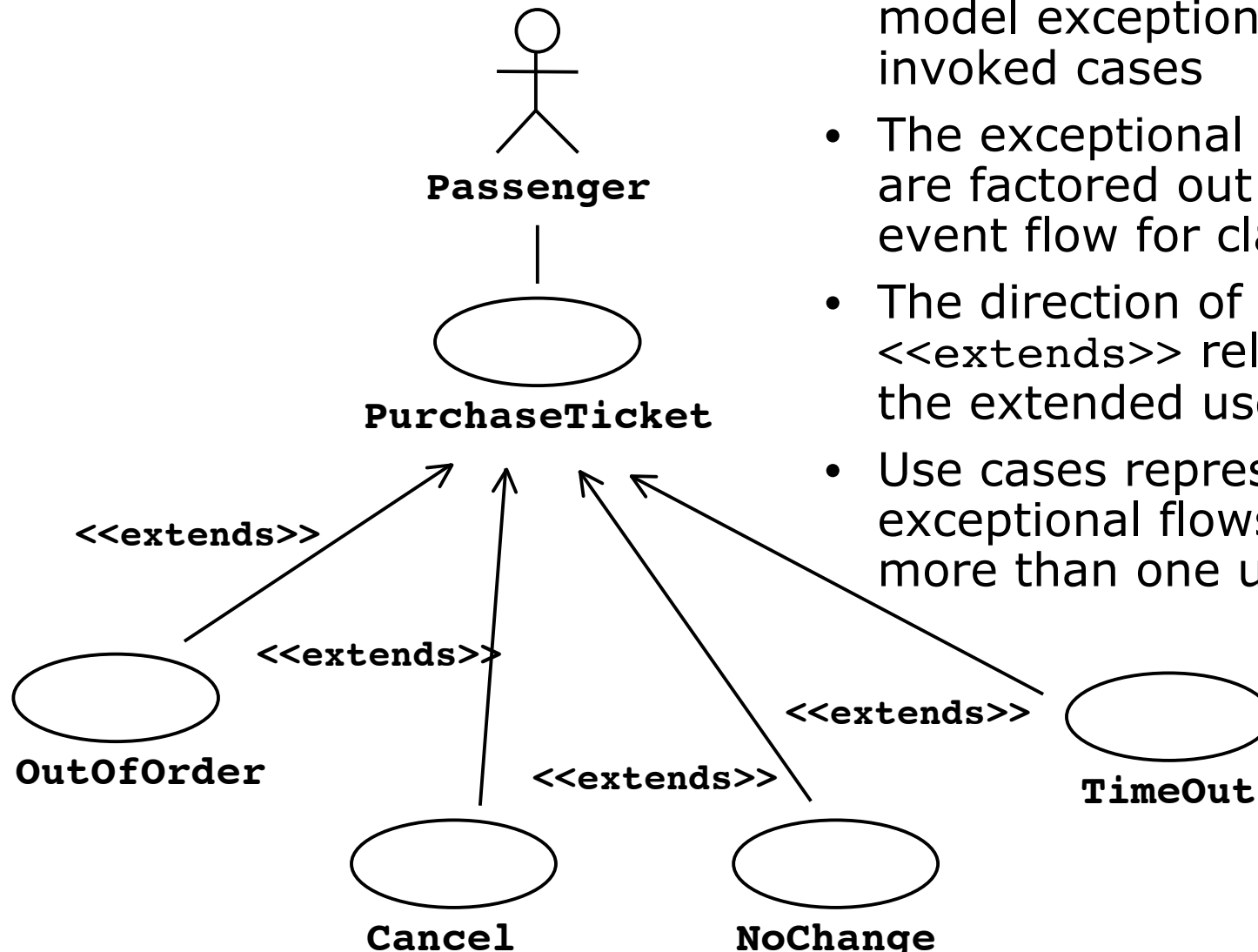

- <<extends>> relationships model exceptional or seldom invoked cases
- The exceptional event flows are factored out of the main event flow for clarity
- The direction of an <<extends>> relationship is to the extended use case
- Use cases representing exceptional flows can extend more than one use case.

The <<includes>> Relationship

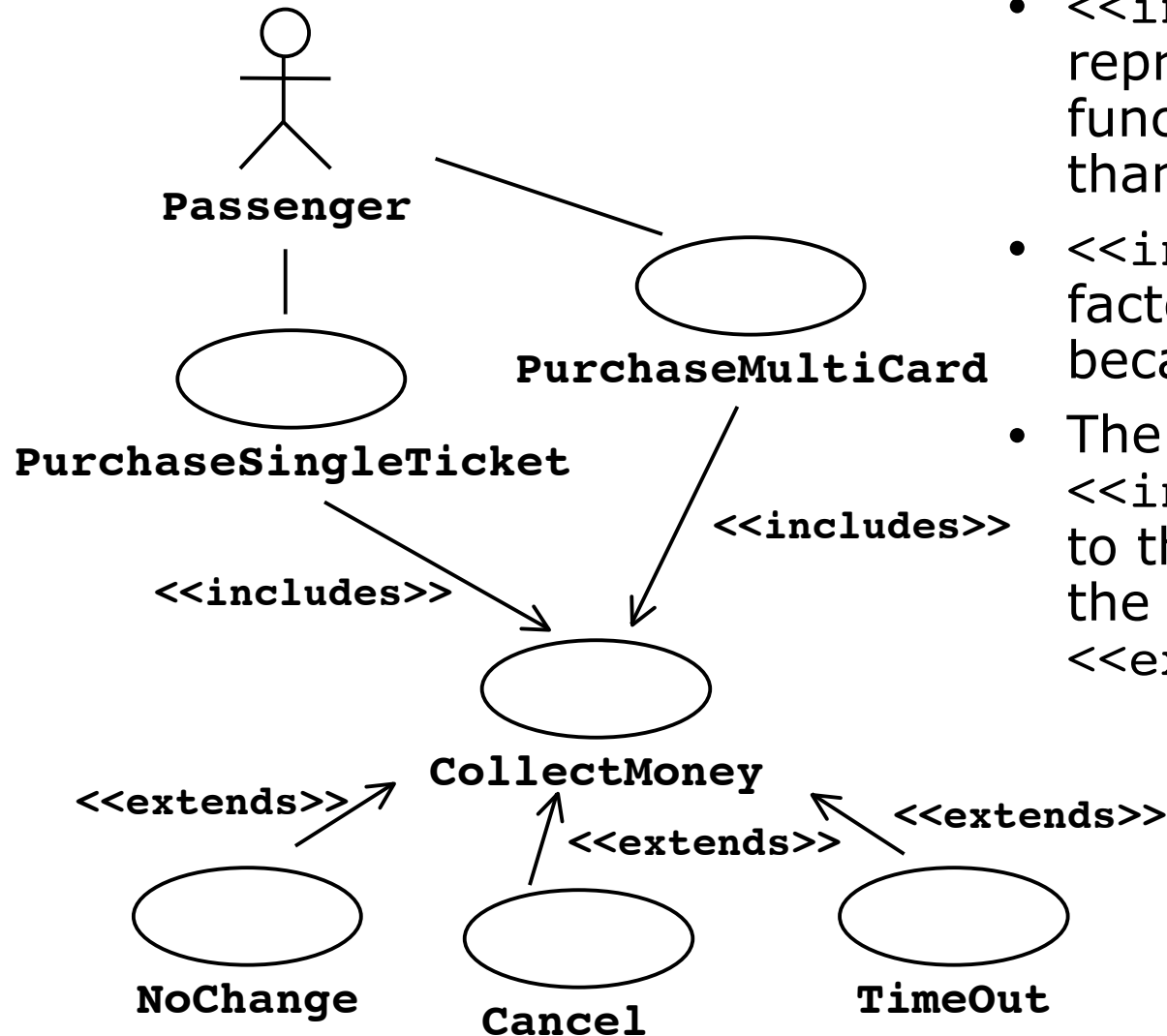

- <<includes>> relationship represents common functionality needed in more than one use case
- <<includes>> behavior is factored out for reuse, not because it is an exception
- The direction of a <<includes>> relationship is to the using use case (unlike the direction of the <<extends>> relationship).

Class Diagrams

- Class diagrams represent the structure of the system
- Used
 - during requirements analysis to model application domain concepts
 - during system design to model subsystems
 - during object design to specify the detailed behavior and attributes of classes.

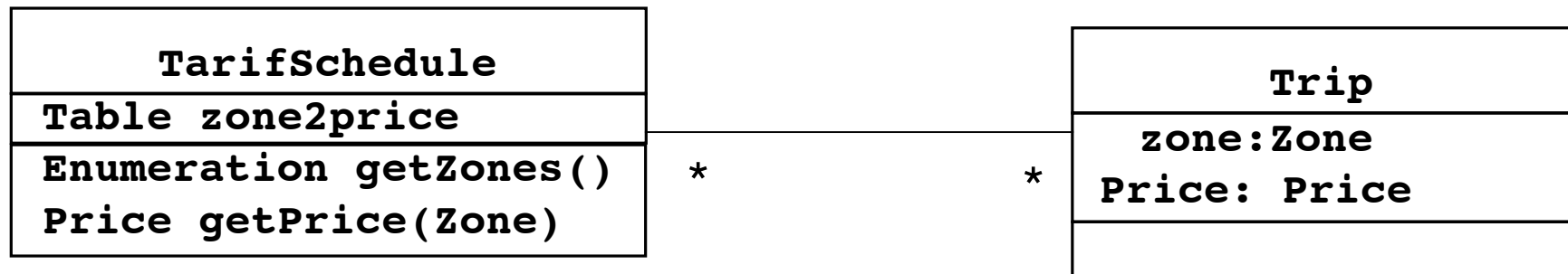

Classes

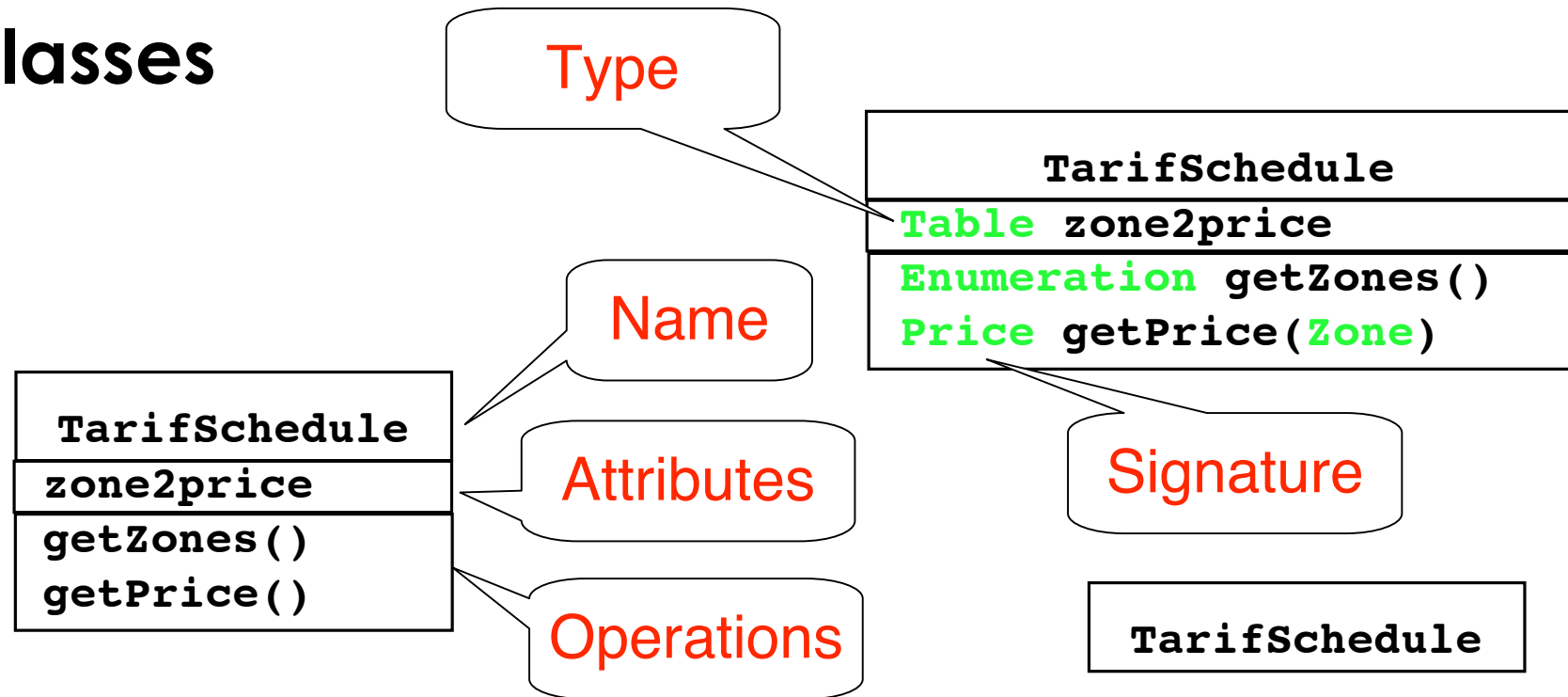

- A **class** represents a concept
- A class encapsulates state (**attributes**) and behavior (**operations**)

Each attribute has a **type**

Each operation has a **signature**

The class name is the only mandatory information

Instances

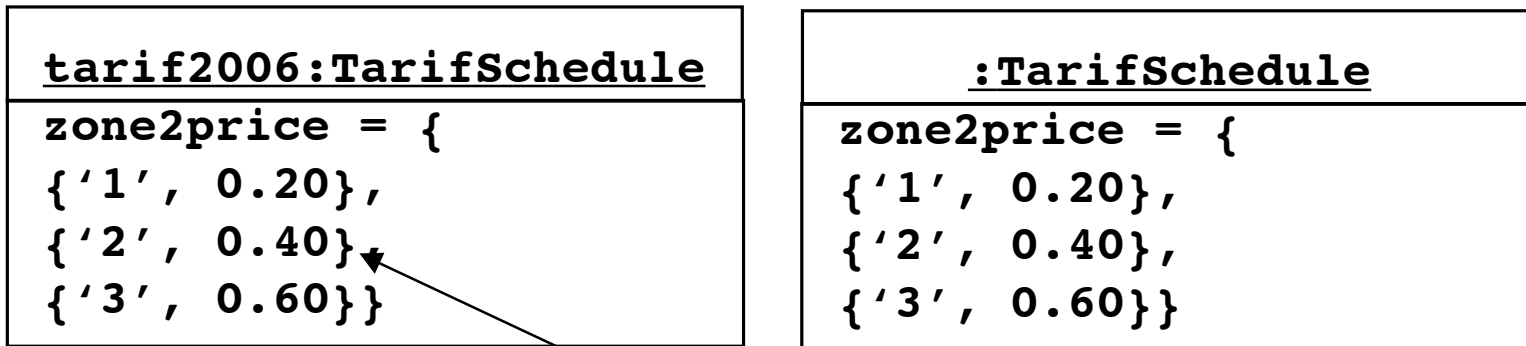

- An **instance** represents a phenomenon
- The attributes are represented with their **values**
- The name of an instance is underlined
- The name can contain only the class name of the instance (anonymous instance)

Actor vs Class vs Object

- **Actor**
 - An entity outside the system to be modeled, interacting with the system ("Passenger")
- **Class**
 - An abstraction modeling an entity in the application or solution domain
 - The class is part of the system model ("User", "Ticket distributor", "Server")
- **Object**
 - A specific instance of a class ("Joe, the passenger who is purchasing a ticket from the ticket distributor").

Associations

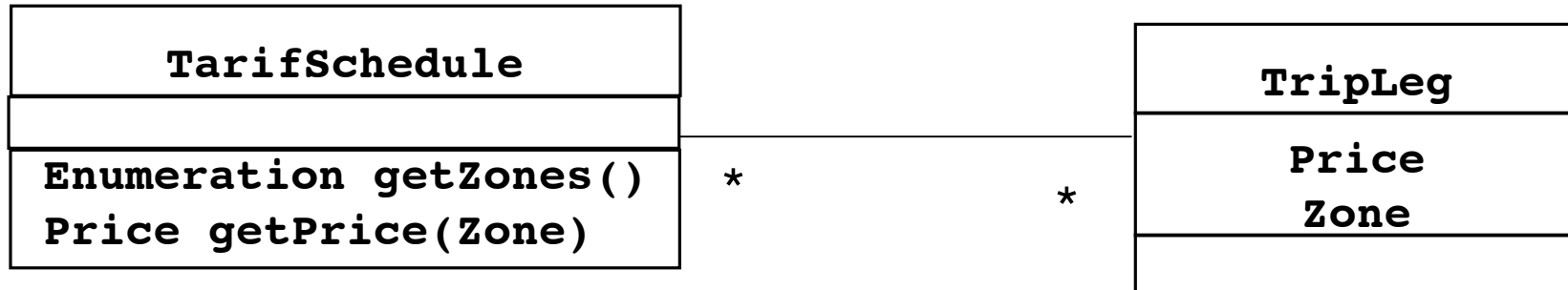

Associations denote relationships between classes

The multiplicity of an association end denotes how many objects the instance of a class can legitimately reference.

1-to-1 and 1-to-many Associations



1-to-1 association



1-to-many association

Many-to-Many Associations



From Problem Statement To Object Model

*Problem Statement: A **stock exchange lists many companies**.
Each company is uniquely identified by a **ticker symbol***

Class Diagram:

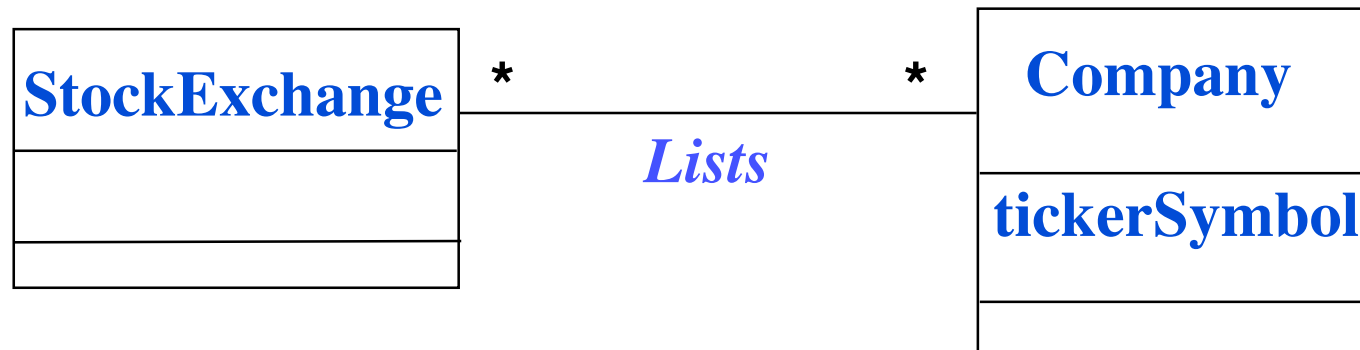

From Problem Statement to Code

Problem Statement : A stock exchange lists many companies.
Each company is identified by a ticker symbol

Class Diagram:

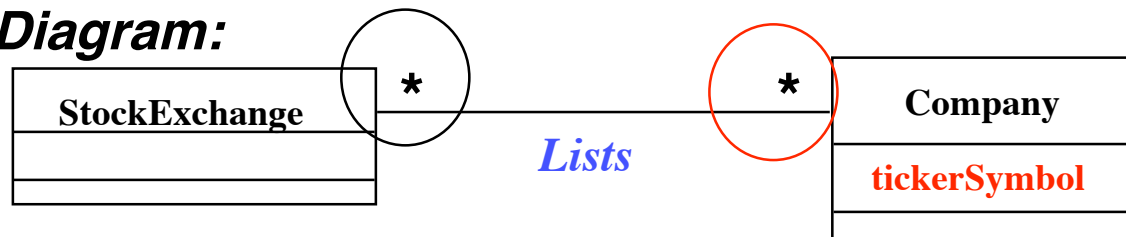

Java Code

```
public class StockExchange
{
    private Vector m_Company = new Vector();
};

public class Company
{
    public int m_tickerSymbol;
    private Vector m_StockExchange = new Vector();
};
```

**Associations
are mapped to
Attributes!**

Aggregation

- An *aggregation* is a special case of association denoting a “consists-of” hierarchy
- The *aggregate* is the parent class, the components are the children classes

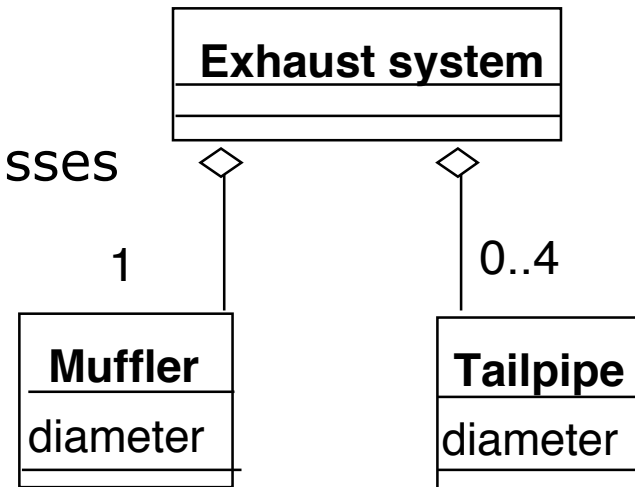

A solid diamond denotes *composition*: A strong form of aggregation where the *life time of the component instances* is controlled by the aggregate (“the whole controls/destroys the parts”)

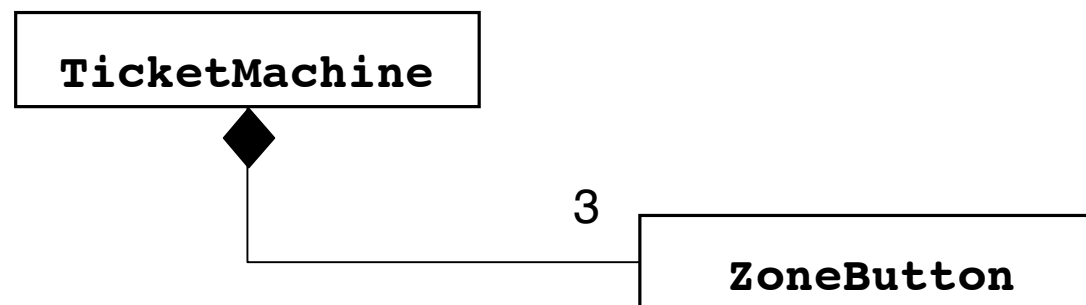

Qualifiers

Without qualification

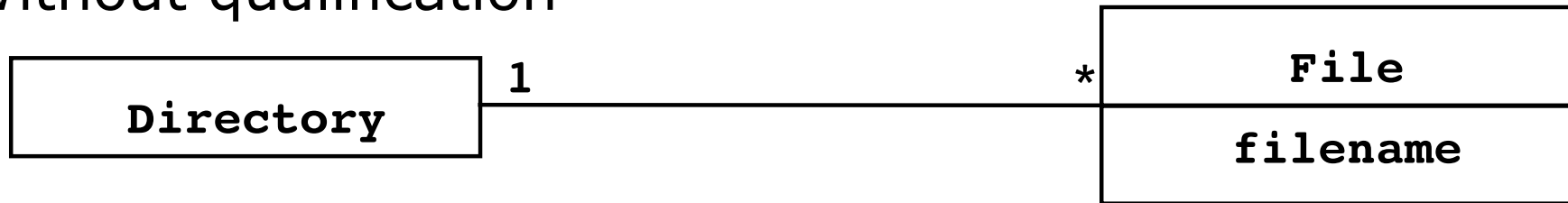

With qualification

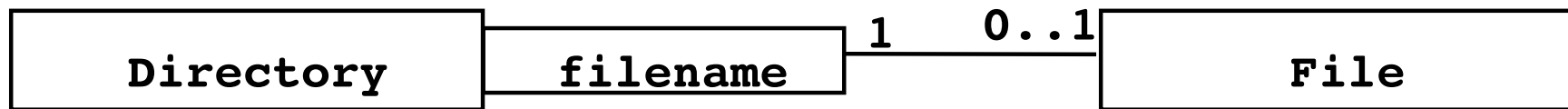

- Qualifiers can be used to reduce the multiplicity of an association

Qualification (2)

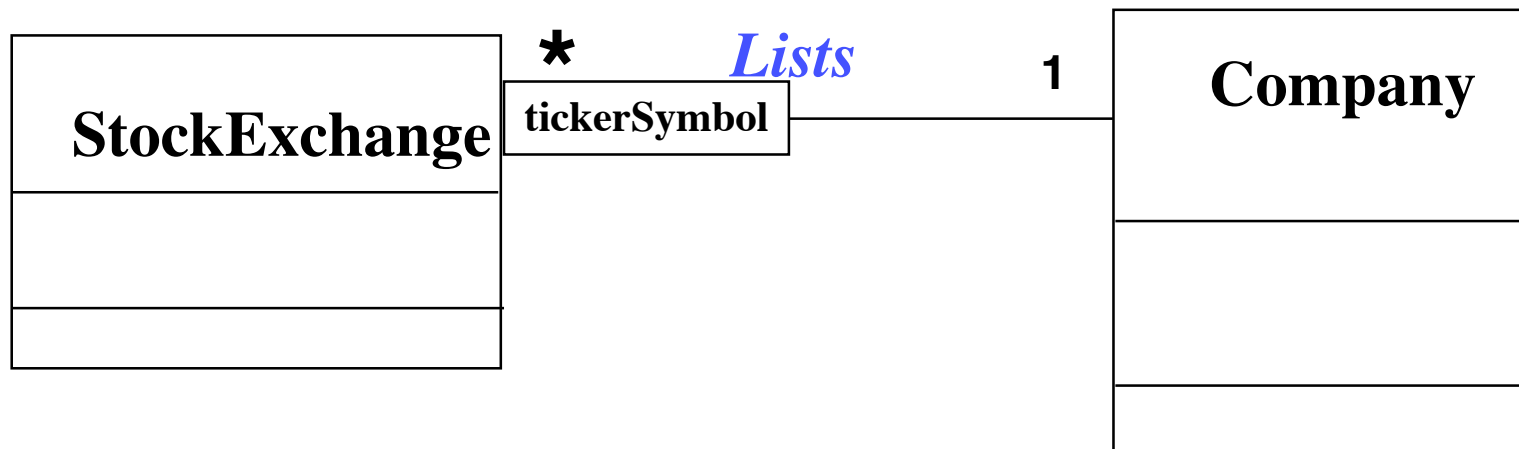

Inheritance

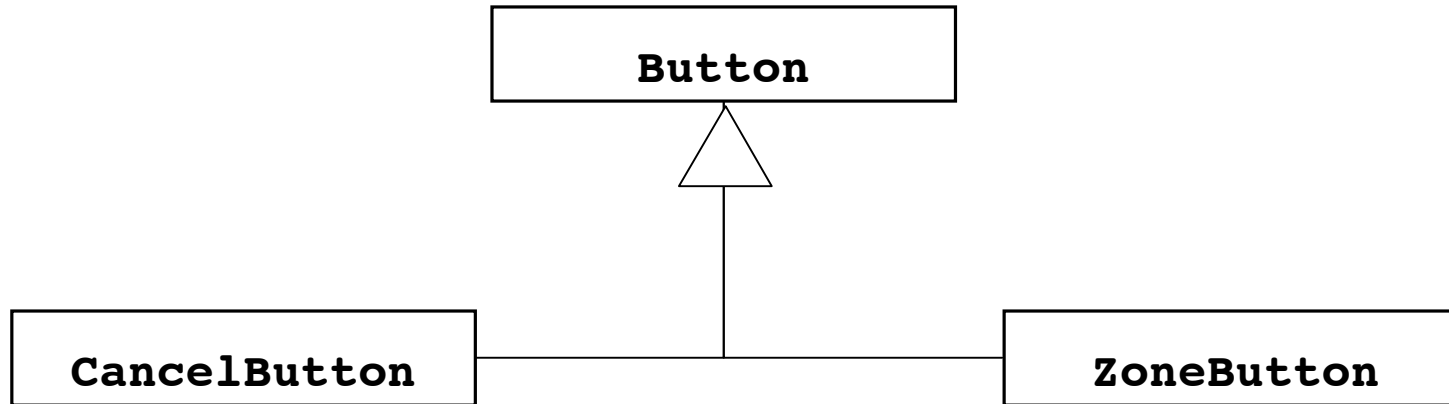

- *Inheritance* is another special case of an association denoting a “kind-of” hierarchy
- Inheritance simplifies the analysis model by introducing a taxonomy
- The **children classes** inherit the attributes and operations of the **parent class**.

Packages

- Packages help you to organize UML models to increase their readability
- We can use the UML package mechanism to organize classes into subsystems

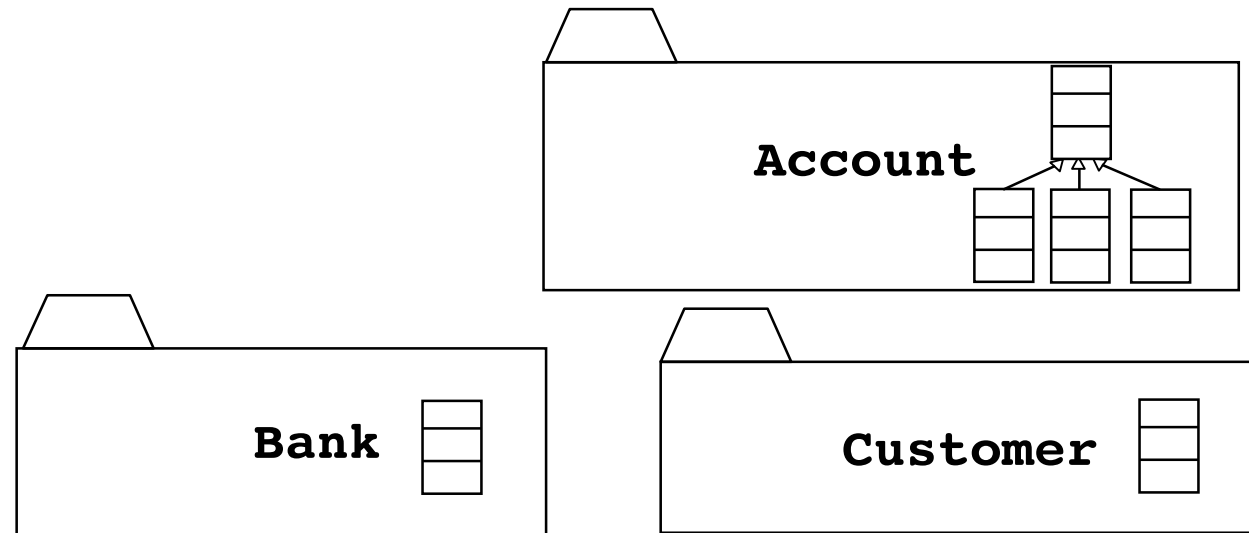

- Any complex system can be decomposed into subsystems, where each subsystem is modeled as a package.

Object Modeling in Practice

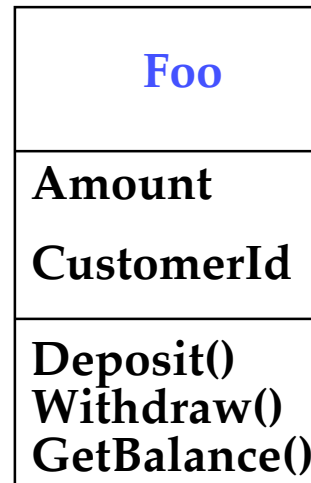

Class Identification: Name of Class, Attributes and Methods

Is **Foo** the right name?

Object Modeling in Practice: Brainstorming

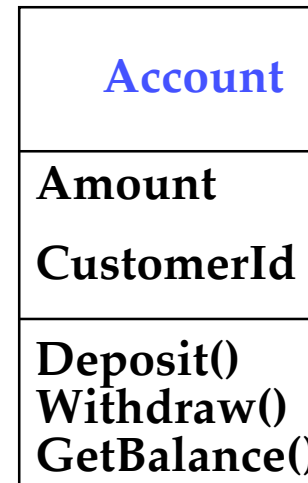
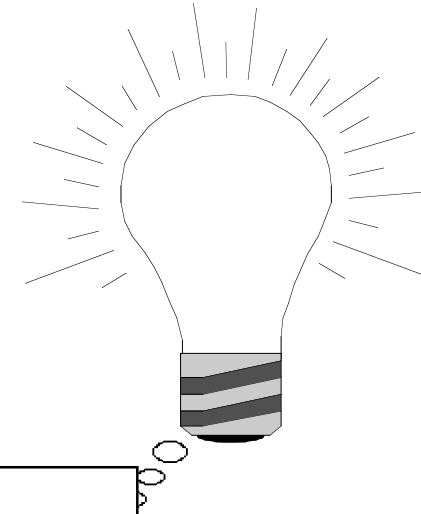
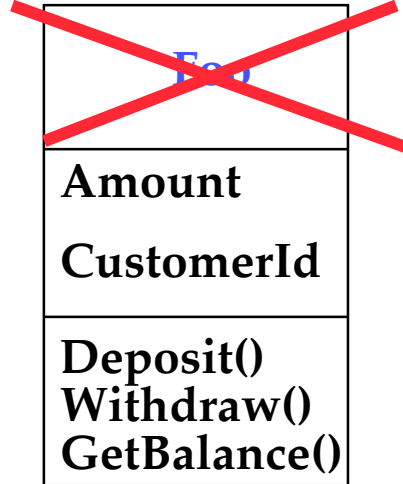
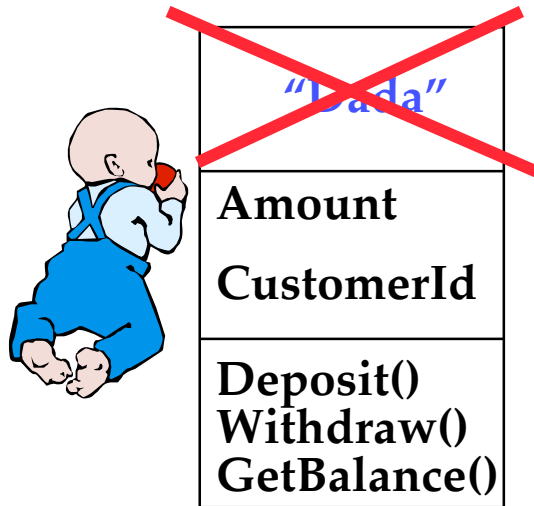

Is **Foo** the right name?

Object Modeling in Practice: More classes

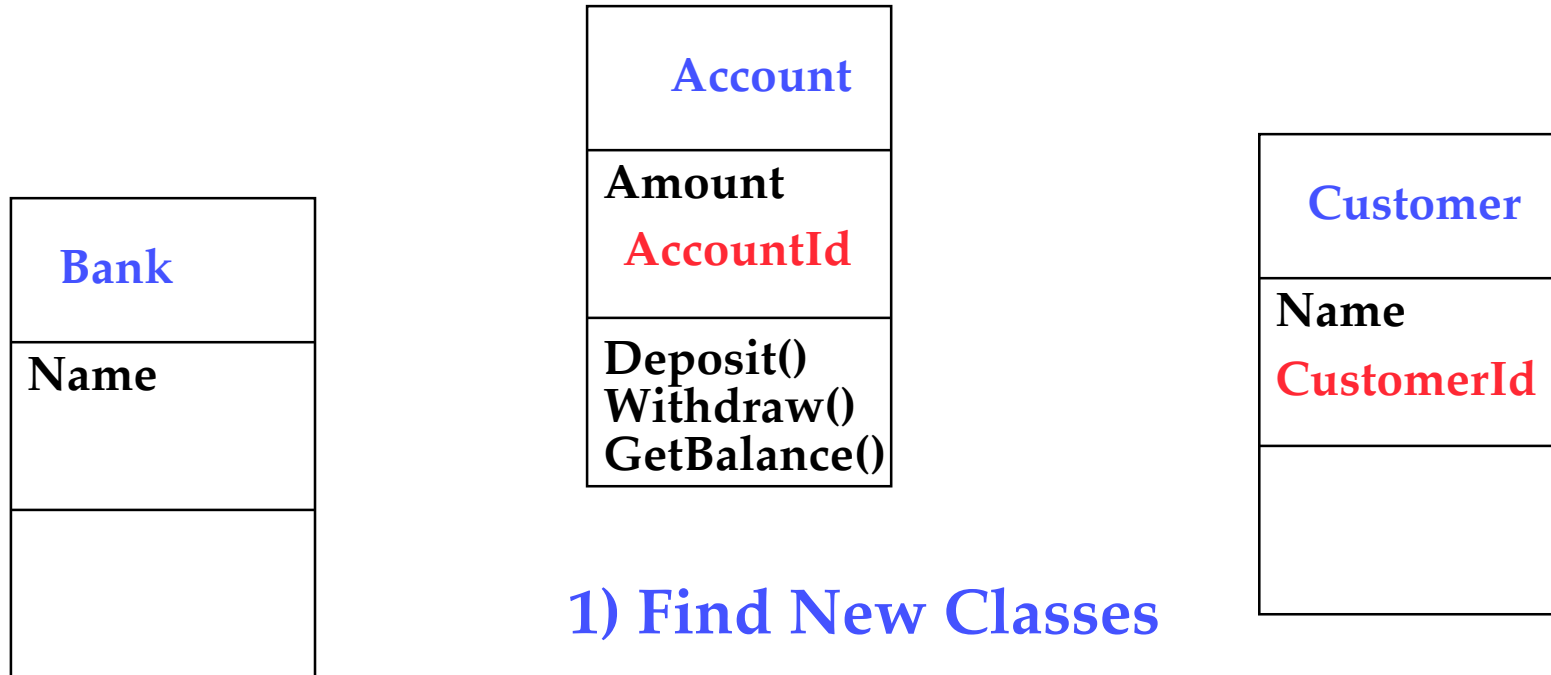

1) Find New Classes

2) Review Names, Attributes and Methods

Object Modeling in Practice: Associations

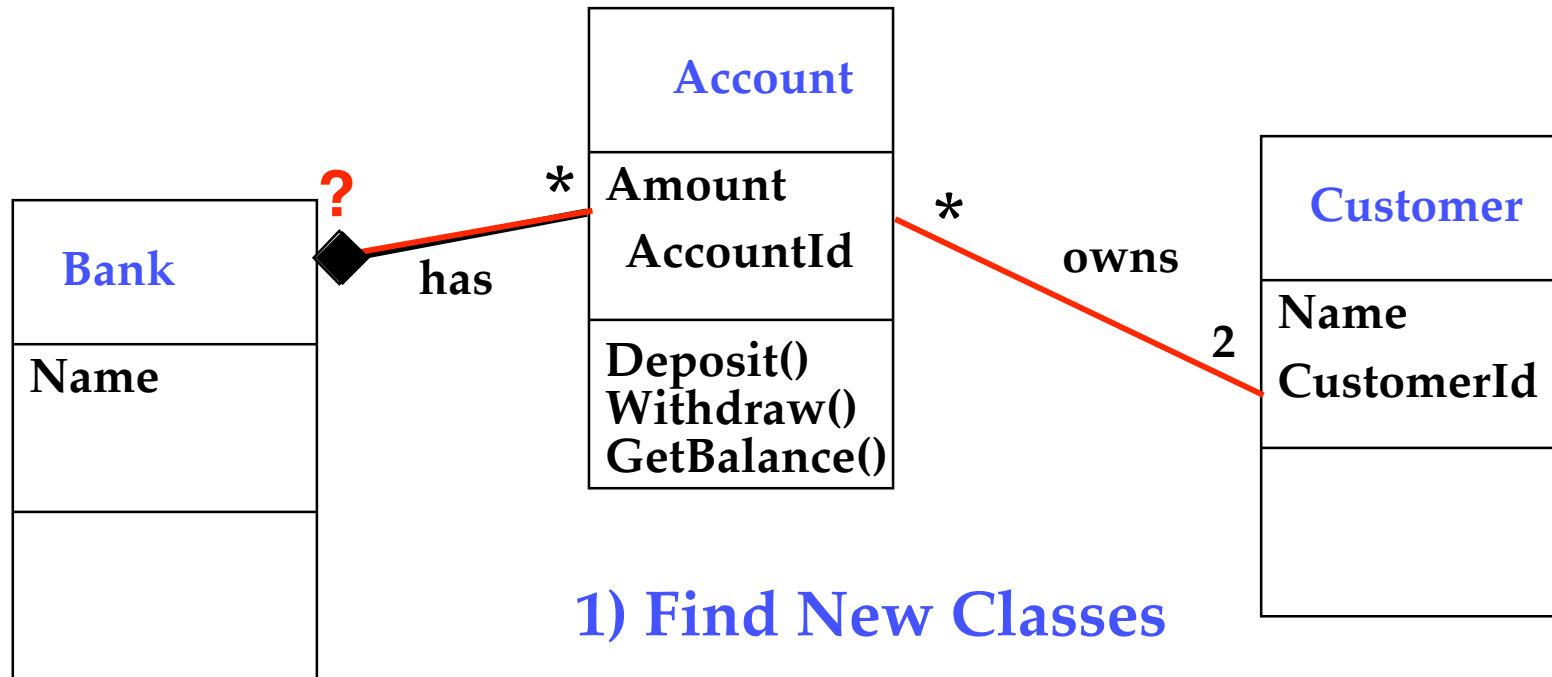

- 1) Find New Classes
- 2) Review Names, Attributes and Methods
- 3) Find Associations between Classes
- 4) Label the generic associations
- 5) Determine the multiplicity of the associations
- 6) Review associations

Practice Object Modeling: Find Taxonomies

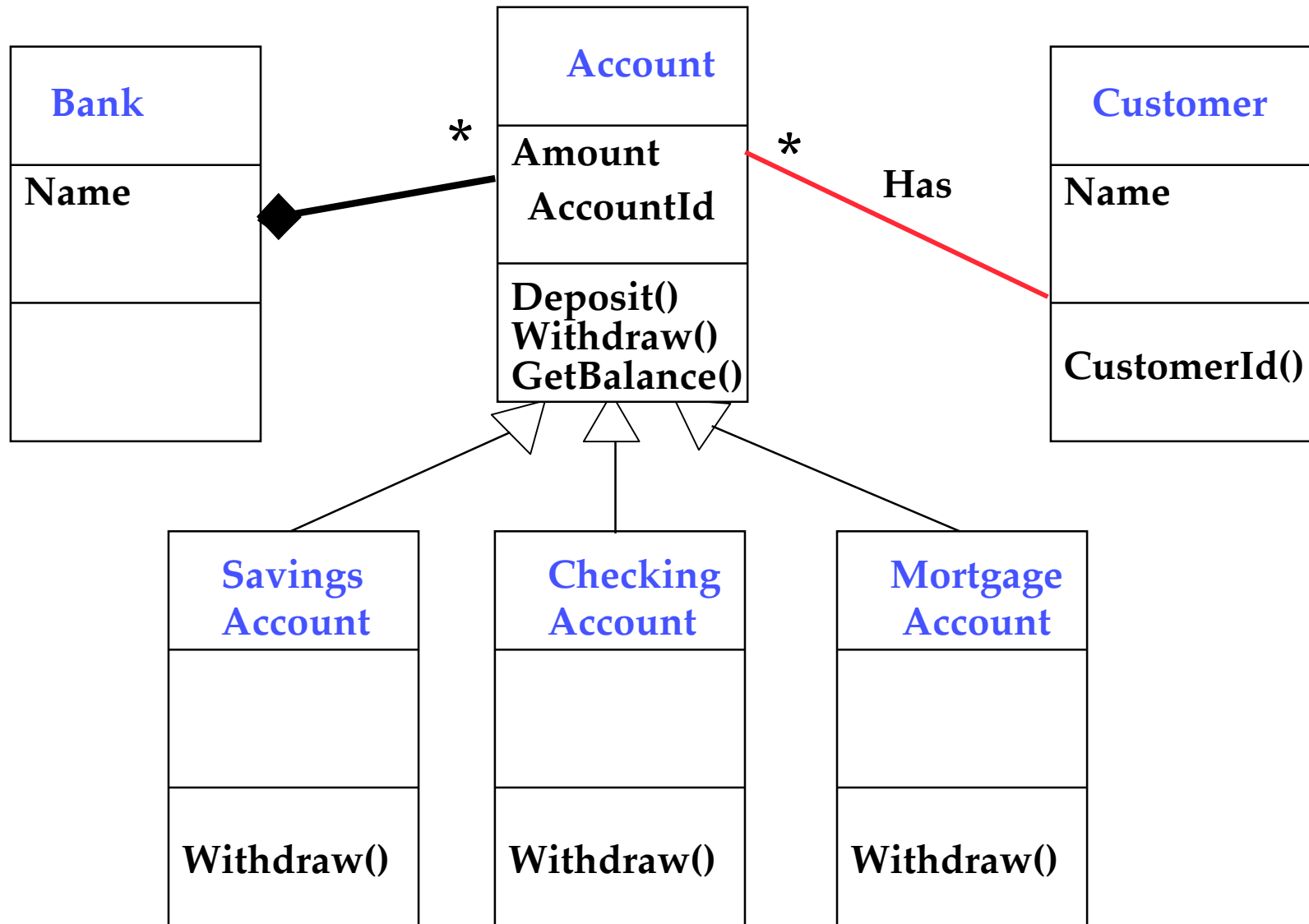

Practice Object Modeling: Simplify, Organize

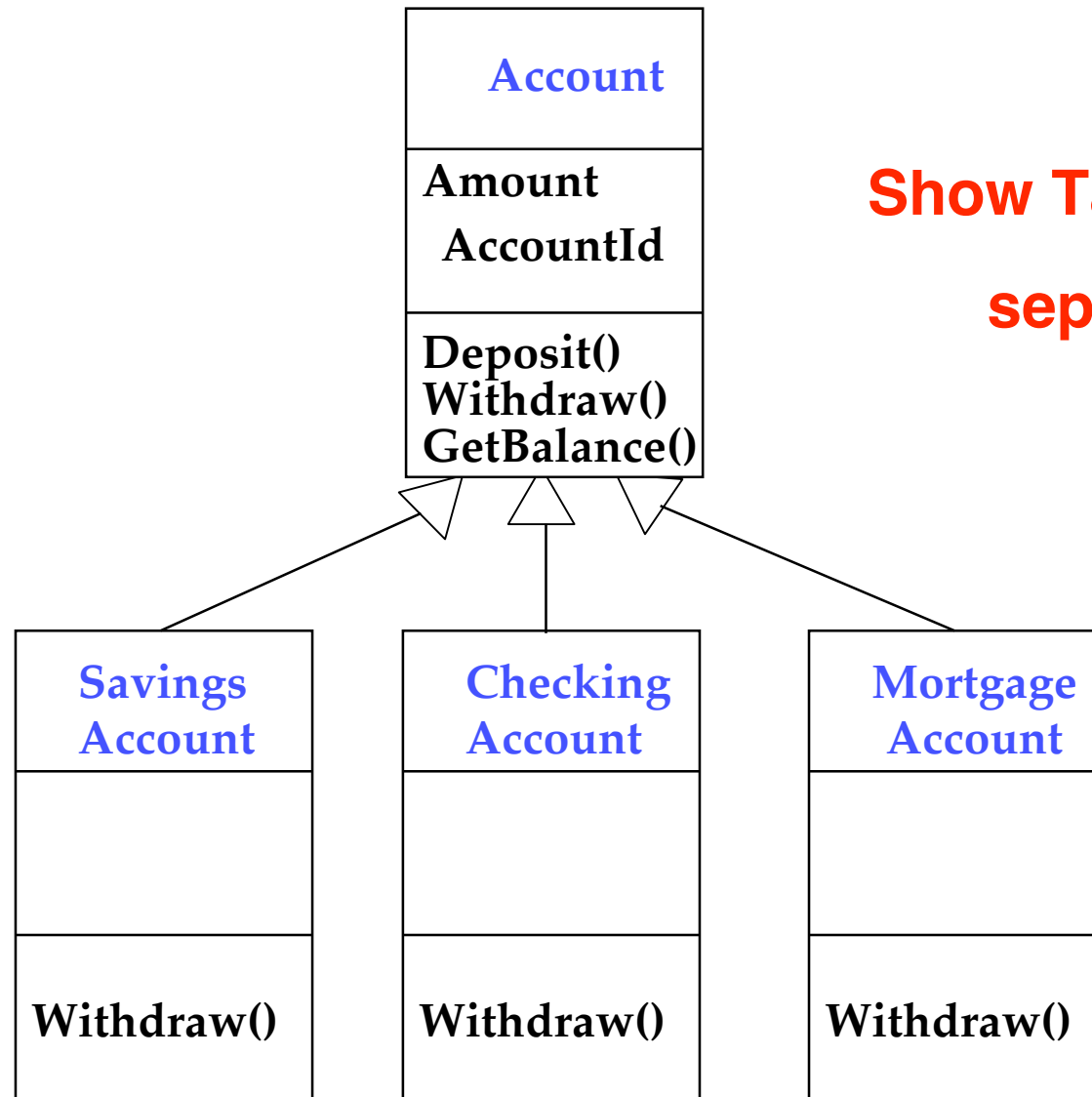

**Show Taxonomies
separately**

Practice Object Modeling: Simplify, Organize

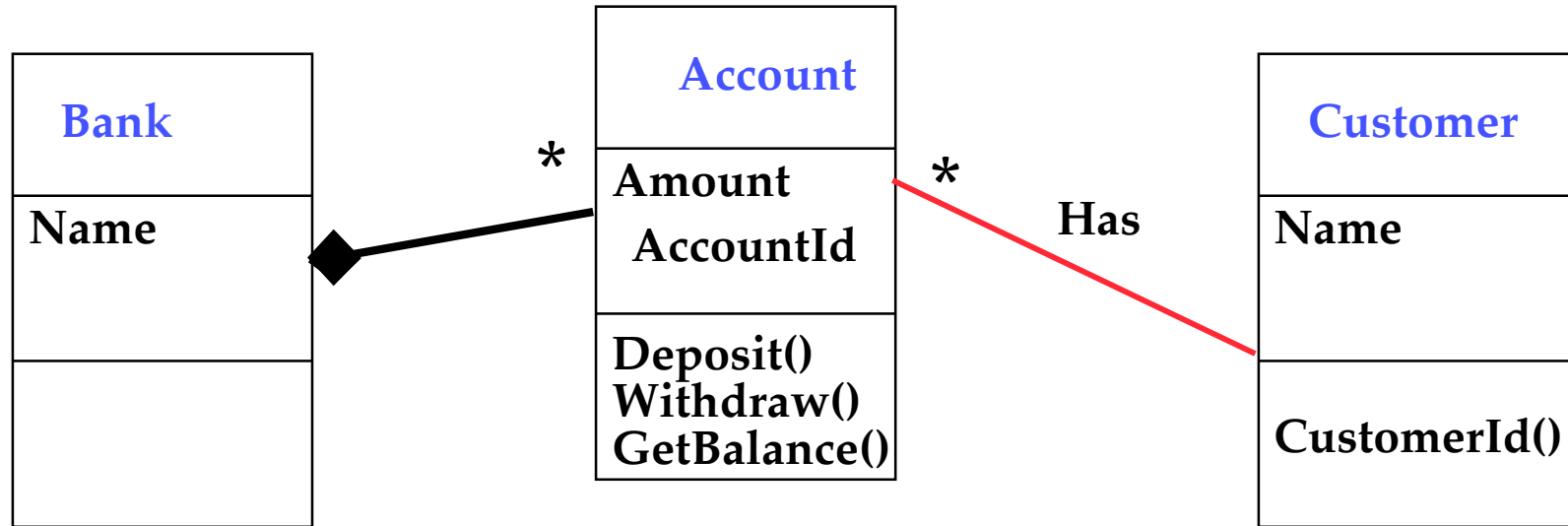

**Use the 7+-2 heuristics
or 5+-2!**

Sequence Diagrams

Focus on Controlflow

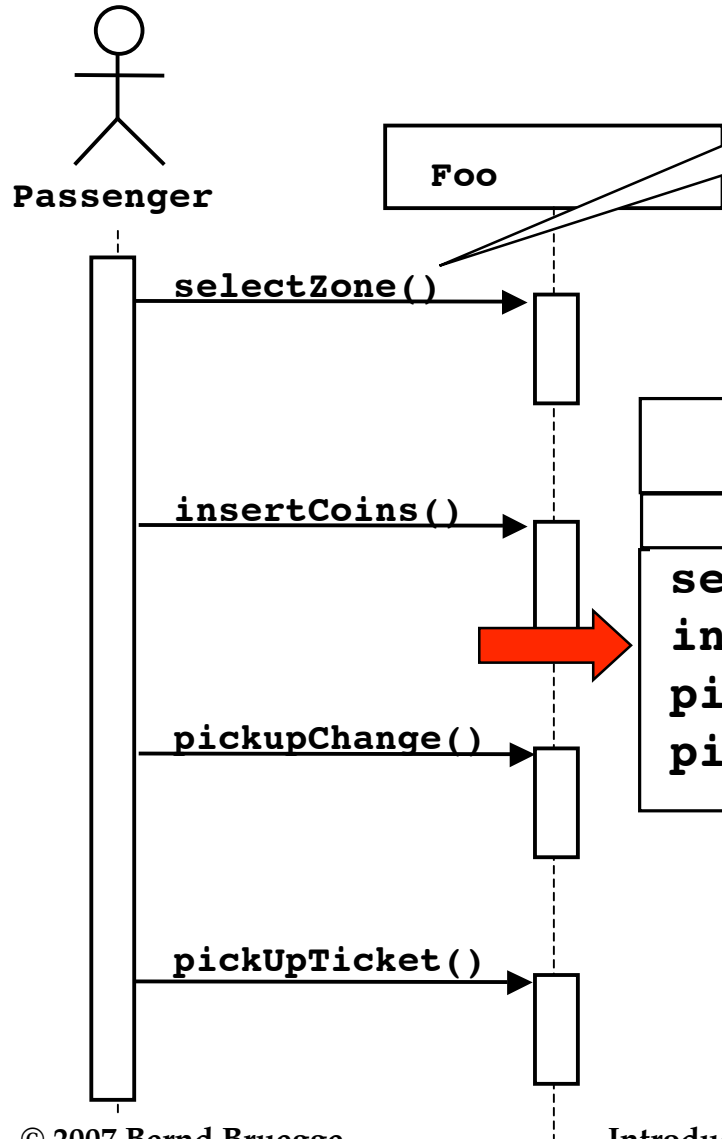

Used during analysis

- To refine use case descriptions
- to find additional objects ("participating objects")

• Used during system design

to refine subsystem interfaces

Messages are represented by arrows

Messages -> Operations on participating Object

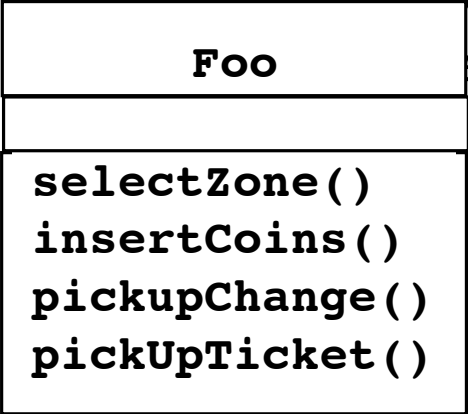

Activations are represented by narrow rectangles

- **Messages** are represented by arrows
- **Activations** are represented by narrow rectangles.

Sequence Diagrams can also model the Flow of Data

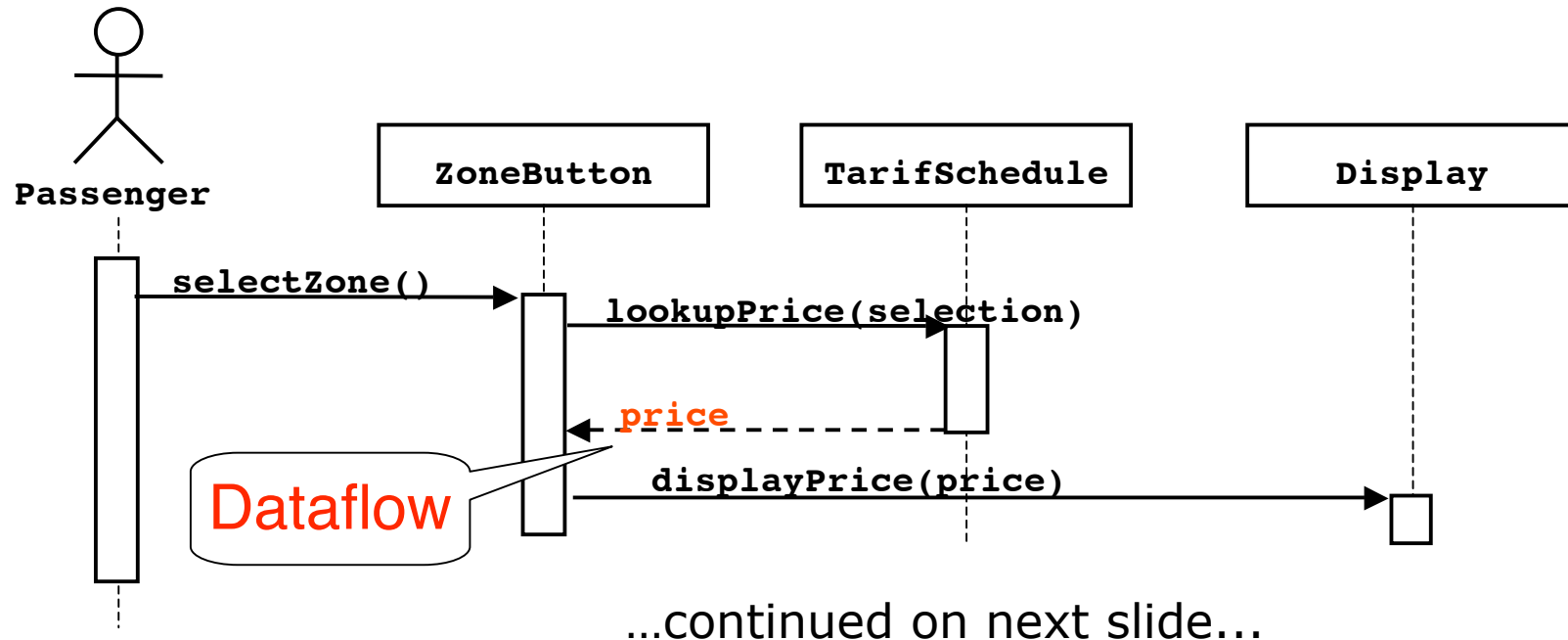

- The source of an arrow indicates the activation which sent the message
- **Horizontal dashed arrows indicate data flow**, for example return results from a message

Sequence Diagrams: Iteration & Condition

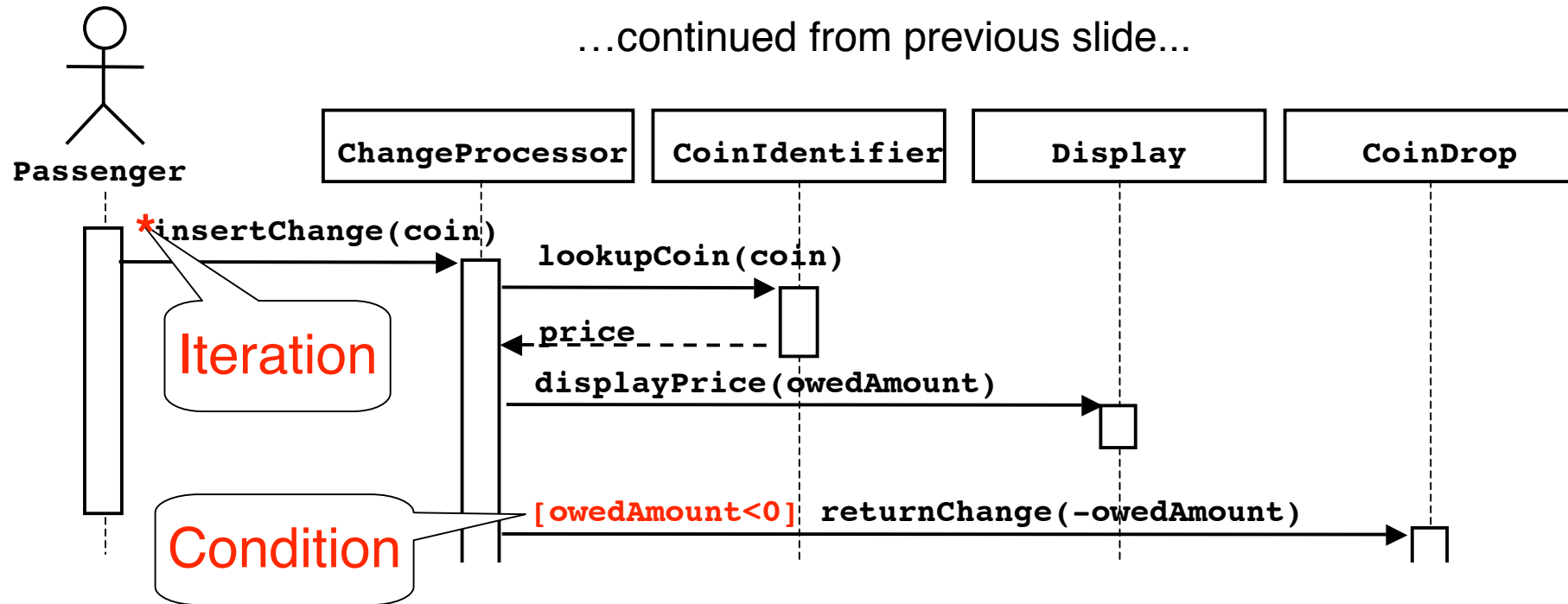

- Iteration is denoted by a * preceding the message name
- Condition is denoted by boolean expression in [] before the message name

Creation and destruction

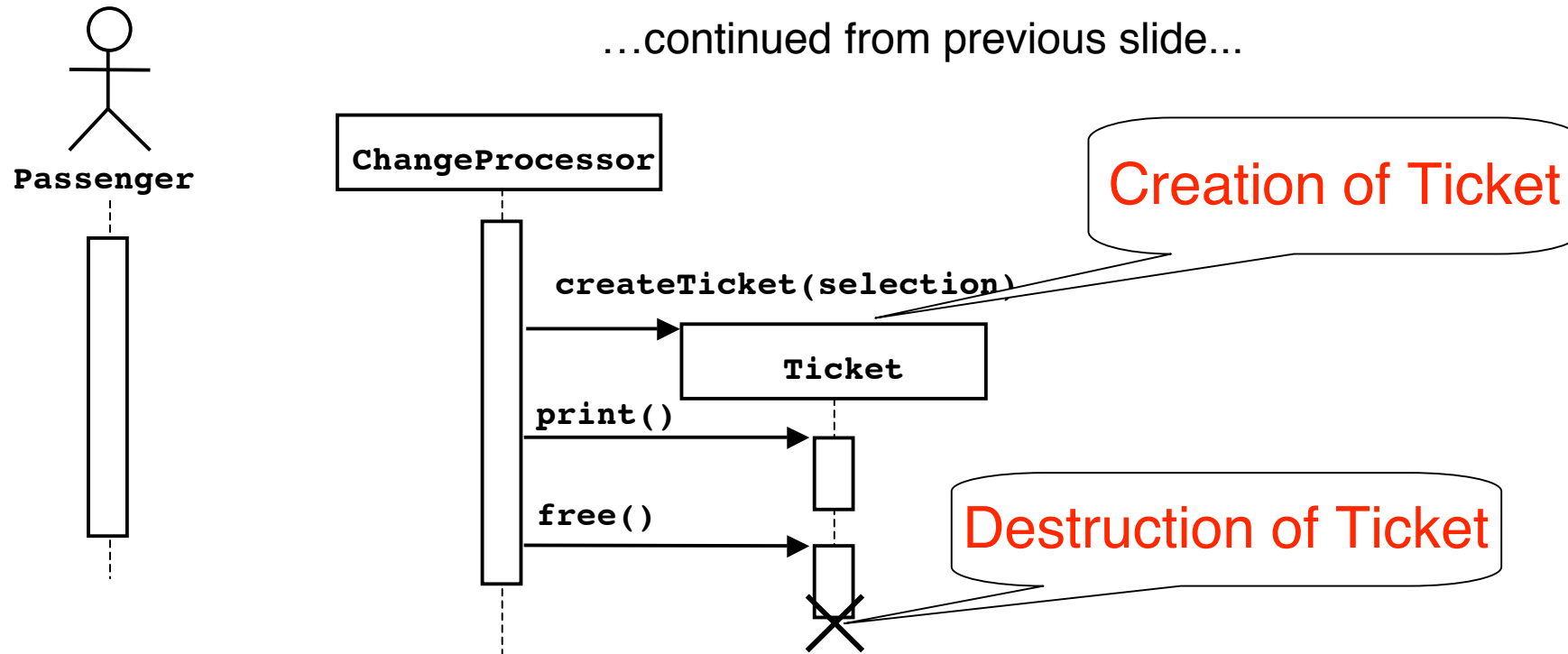

- Creation is denoted by a message arrow pointing to the object
- Destruction is denoted by an X mark at the end of the destruction activation
 - In garbage collection environments, destruction can be used to denote the end of the useful life of an object.

Sequence Diagram Properties

- UML sequence diagram represent *behavior in terms of interactions*
- Useful to identify or find missing objects
- Time consuming to build, but worth the investment
- Complement the class diagrams (which represent structure).

Outline of this Class

- A more detailed view on
 - ✓ Use case diagrams
 - ✓ Class diagrams
 - ✓ Sequence diagrams
 - Activity diagrams

Activity Diagrams

- An activity diagram is a special case of a state chart diagram
- The states are activities (“functions”)
- An activity diagram is useful to depict the workflow in a system

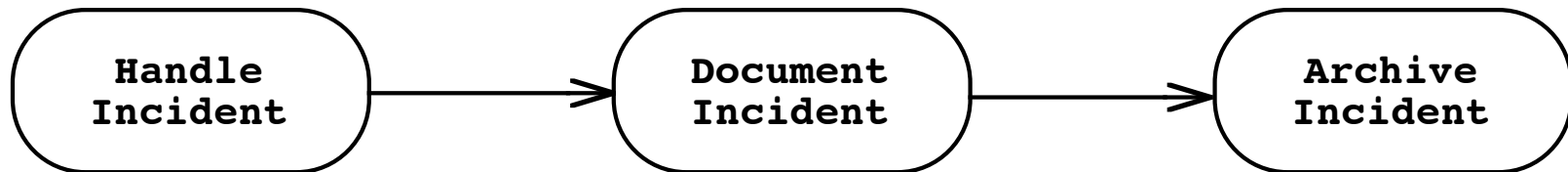

Activity Diagrams allow to model Decisions

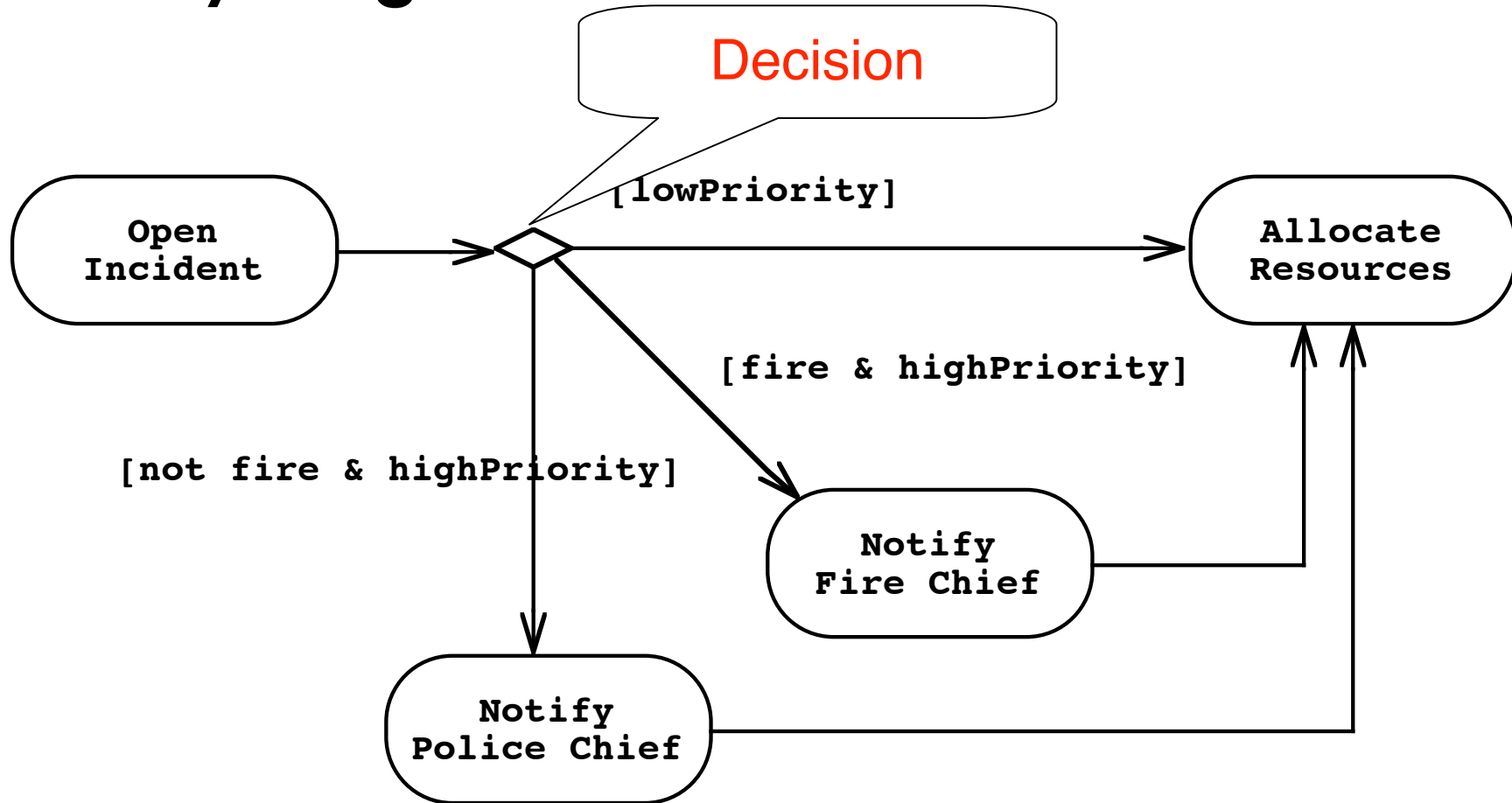

Activity Diagrams can model Concurrency

- Synchronization of multiple activities
- Splitting the flow of control into multiple threads

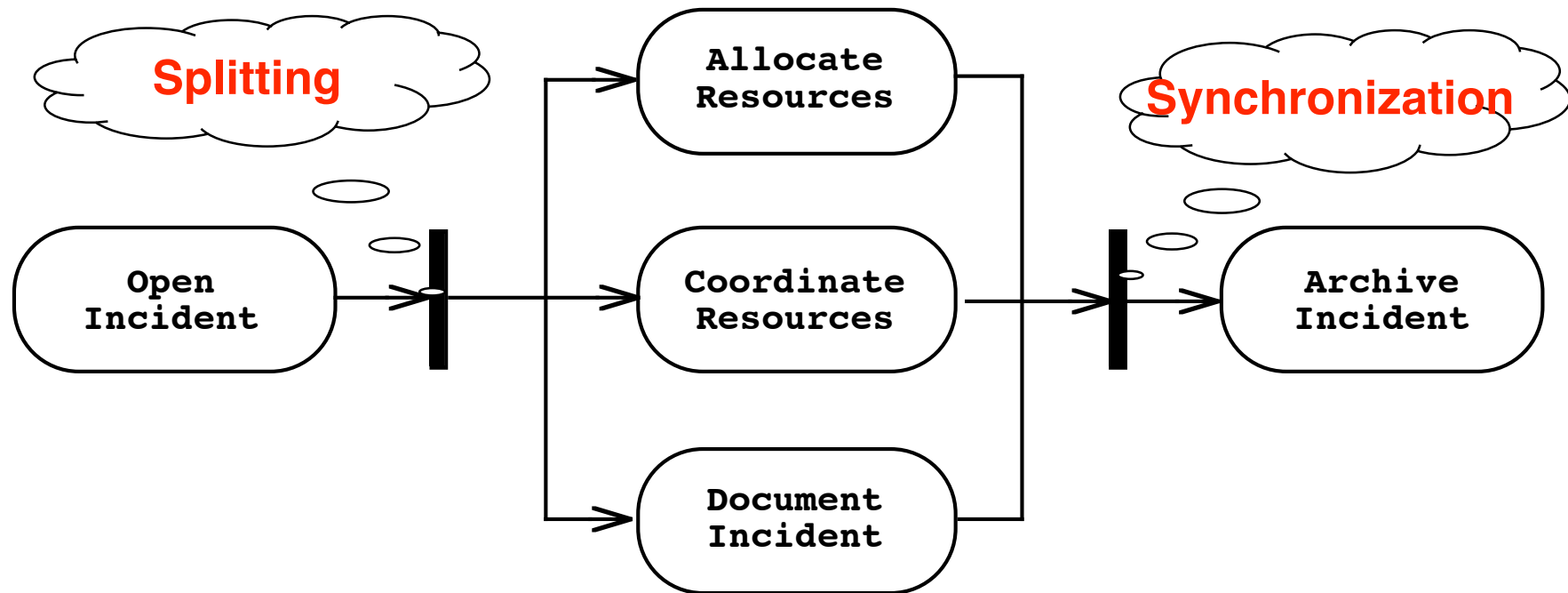

Activity Diagrams: Grouping of Activities

- Activities may be grouped into **swimlanes** to denote the object or subsystem that implements the activities.

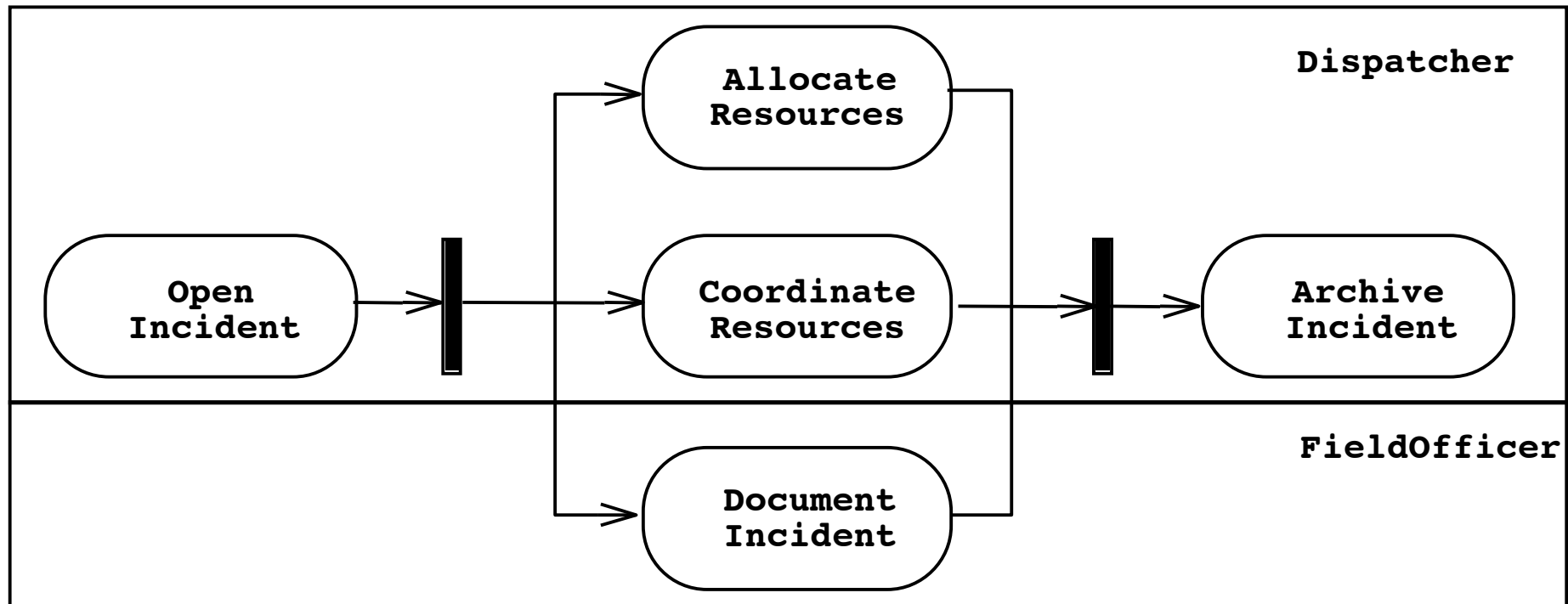

Activity Diagram vs. Statechart Diagram

Statechart Diagram for Incident

Focus on the set of attributes of a single abstraction (object, system)

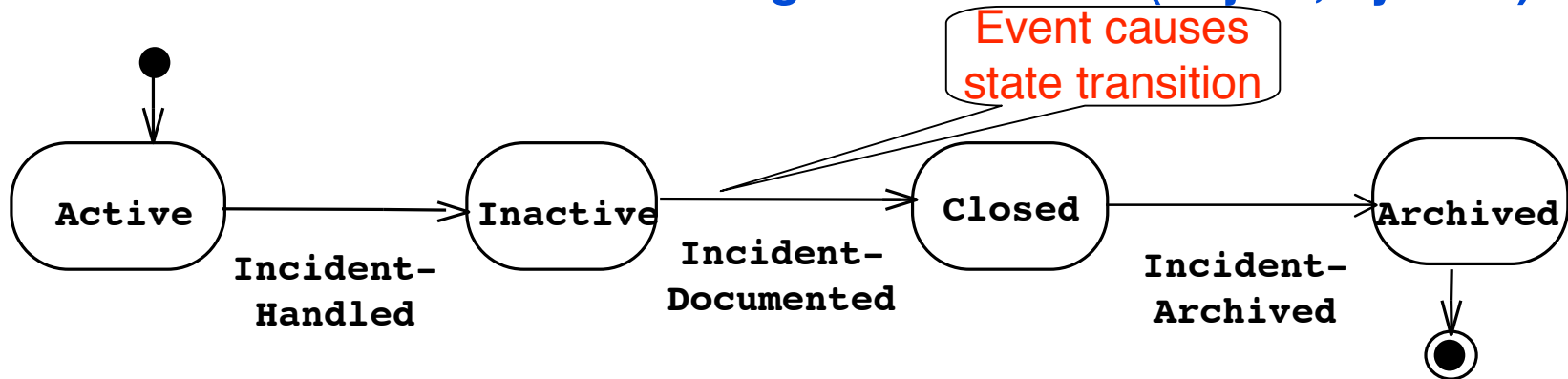

Activity Diagram for Incident

Focus on dataflow in a system

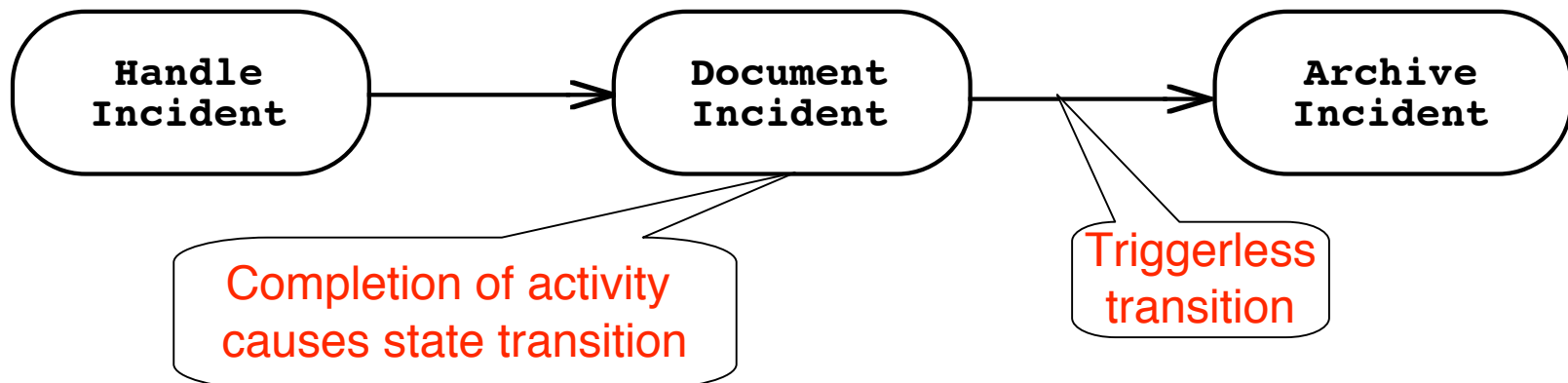

UML Summary

- UML provides a wide variety of notations for representing many aspects of software development
 - Powerful, but complex
- UML is a programming language
 - Can be misused to generate unreadable models
 - Can be misunderstood when using too many exotic features
- We concentrated on a few notations:
 - Functional model: Use case diagram
 - Object model: class diagram
 - Dynamic model: sequence diagrams, statechart and activity diagrams